

SISTEMA CINQUE ENGINEERING SRL PRESENTA

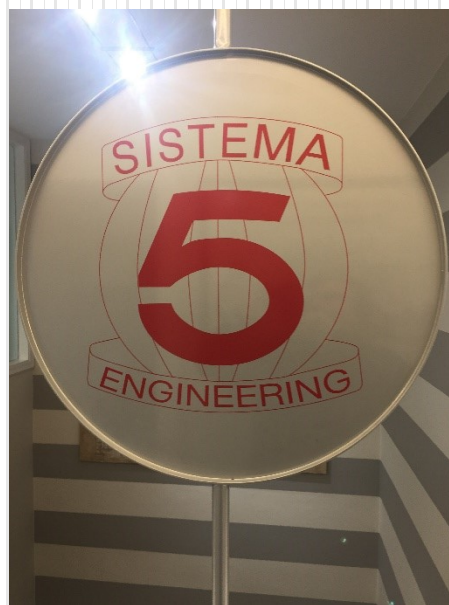

STABILIMENTO DI SOLIERA (MO)

MAGAZZINO E LOGISTICA



SALA FORMAZIONE E CORSI UTILIZZO IMPIANTI

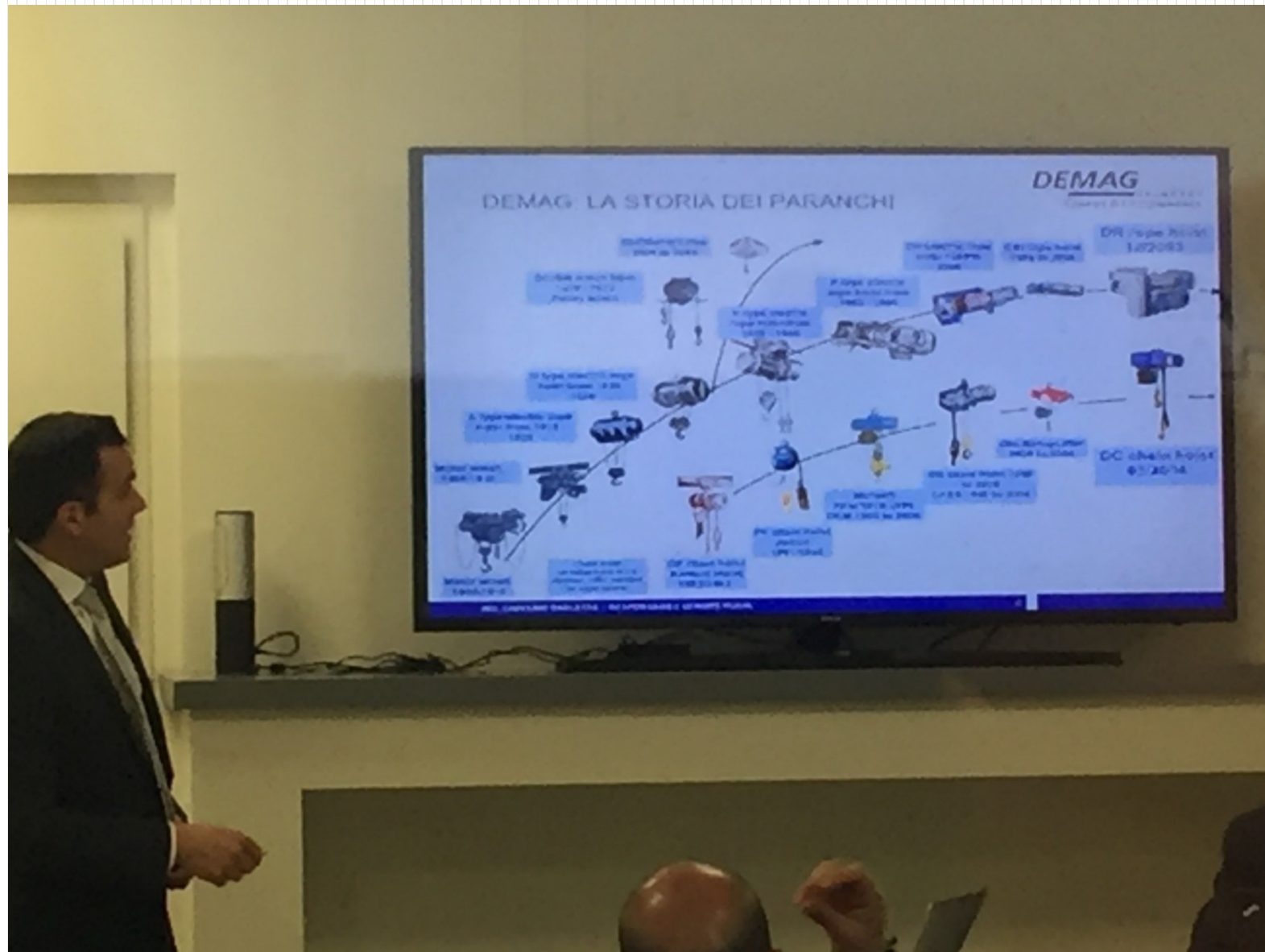

FORMAZIONE TECNICI E VENDITORI



CORSI FORMAZIONE CON CATERING



MAGAZZINO RICAMBI DEMAG



Missione aziendale

- COSTRUTTORI DI IMPIANTI DI SOLLEVAMENTO CON PRODOTTI DEMAG .
- RIVENDITORE AUTORIZZATO DEMAG E AGENZIA DI VENDITA DEMAG.
- SIAMO A DISPOSIZIONE PER RISOLVERVI QUALSIASI PROBLEMA INERENTE IL SOLLEVAMENTO
- GESTIAMO DIRETTAMENTE CON L' AUSILIO DI TECNICI ALTAMENTE SPECIALIZZATI E COSTANTEMENTE FORMATI I RELATIVI SERVIZI DI MONTAGGIO E COLLAUDO DEGLI IMPIANTI , MANUTENZIONE ORDINARIA E FORNITURE RICAMBI.

Il team

- N° 5 INGEGNERI MECCANICI STRUTTURISTI
- N° 1 INGEGNERE MECCANICO PROGETTISTA DI IMPIANTI DI SOLLEVAMENTO
- N° 2 DISEGNATORI MECCANICI (ESTERNI)
- N° 1 TECNICO PROGETTISTA DI ATTREZZI E IMPIANTI SPECIALI (ESTERNO)
- N° 1 TECNICO PER RILIEVI DI CANTIERE PROVE NON DISTRUTTIVE DIAGNOSTICHE E COLLAUDI
- N° 2 IMPIEGATI AMMINISTRATIVI
- N° 8 TECNICI PER SERVICE MUNITI DI FURGONE OFFICINA
- N°8 MONTATORI IMPIANTI

Prodotti

- Paranchi DEMAG



Dc-Com / Dc-Pro



DCBS



Manulift



200th Year
Anniversary
Edition

PARANCHI A FUNE

Demag DMR Wire Rope Hoist

Configurations to meet your
heavy lifting needs!



Single Girder



Double Girder



Foot Mounted



Drum & Rope Winch



In-Line, Monorail

DEMAG.....

- Sottoganci speciali per gru a bandiera e impianti sospesi kbk

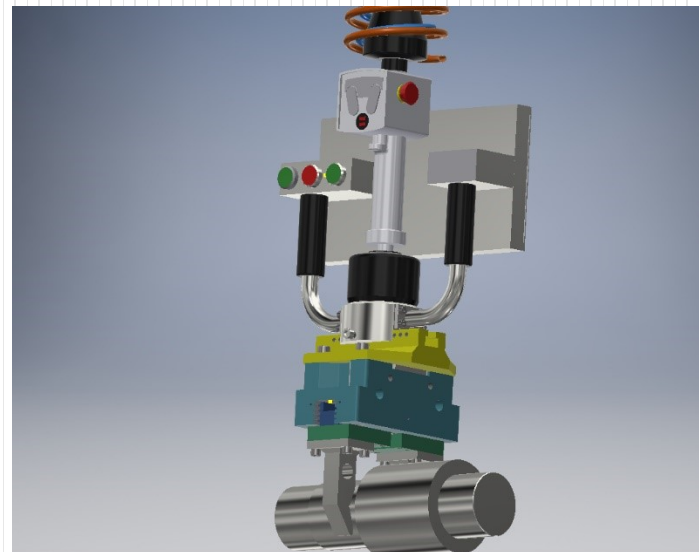
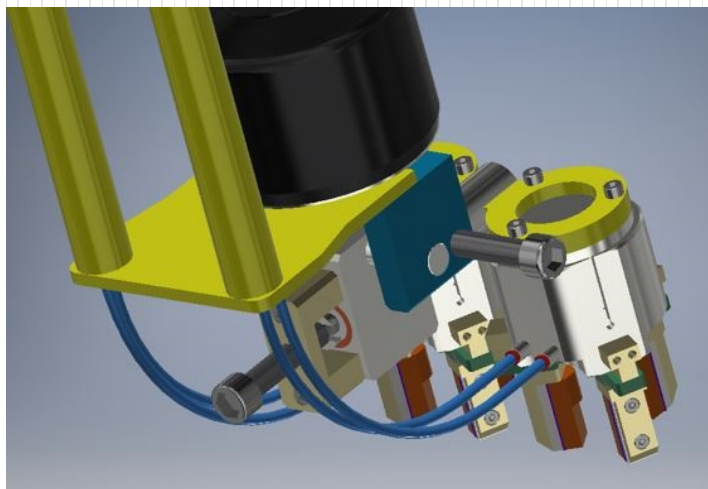

- Impianti sospesi kbk DEMAG



ACCIAO VERNICIATO



ALLUMINIO

- Impianti sospesi kbk DEMAG realizzati

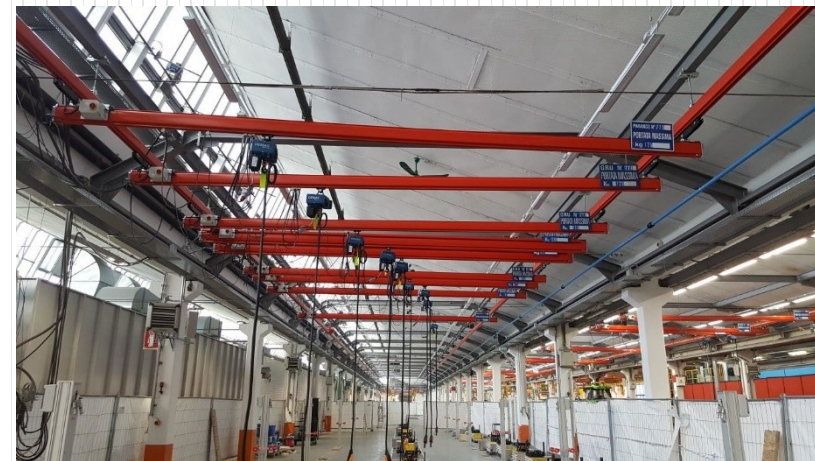

- Gru a ponte DEMAG realizzate



IMPIANTI DEMAG CON GRU A PONTE DA 20 TON

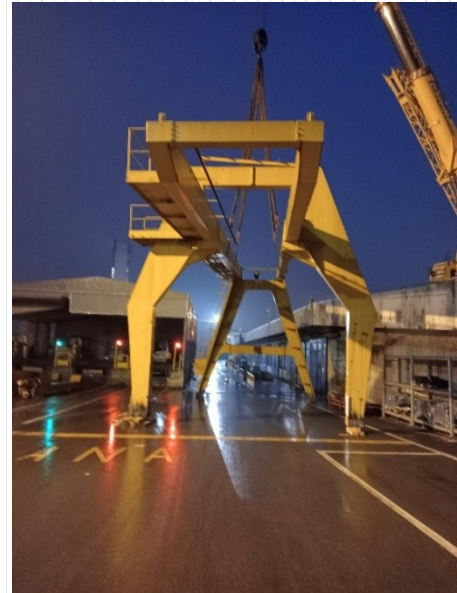
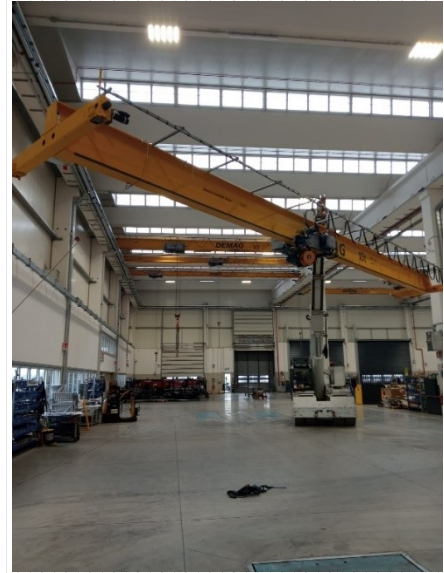
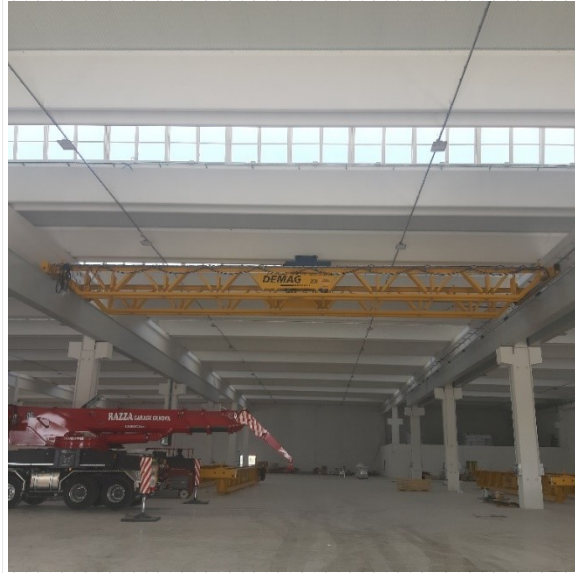

- Ingegneria
- Costruzione
- Montaggio strutture tecnologiche

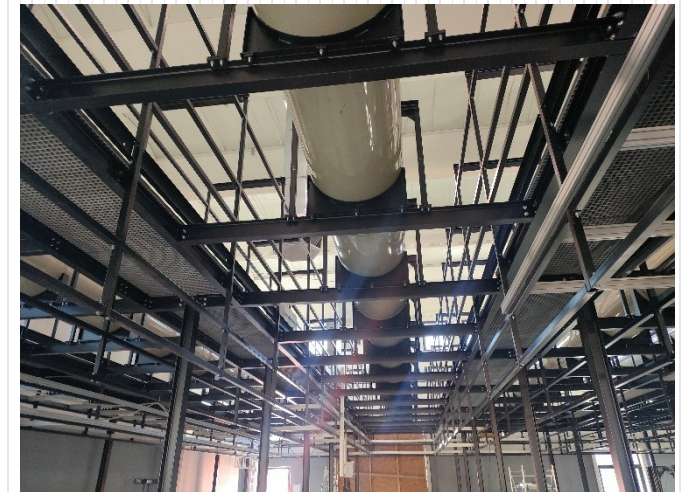
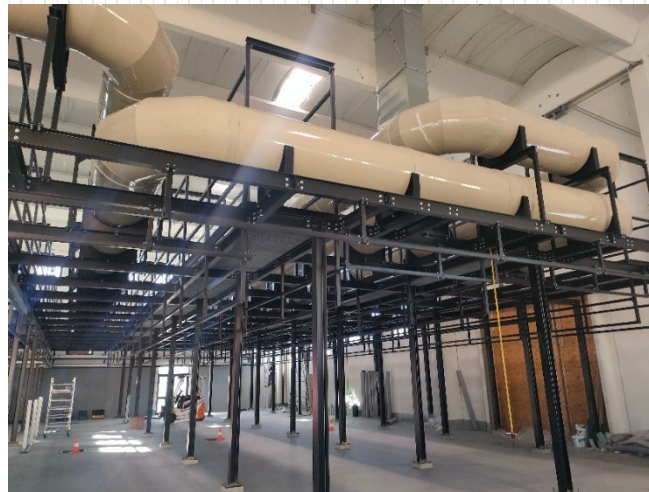

- Strumenti diagnostici



LASER



PUNTATORE

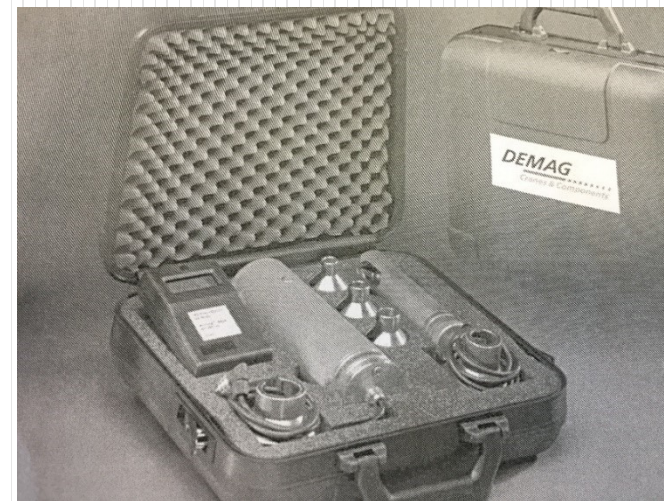

DINAMOMETRIA



ANALISI SCAN-LASER PAVIMENTI

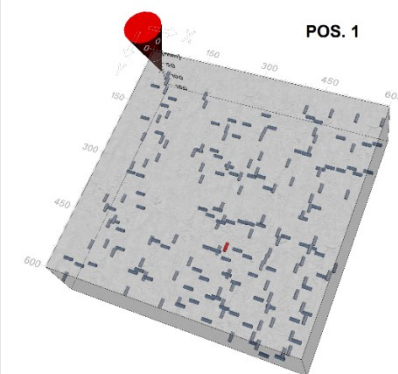
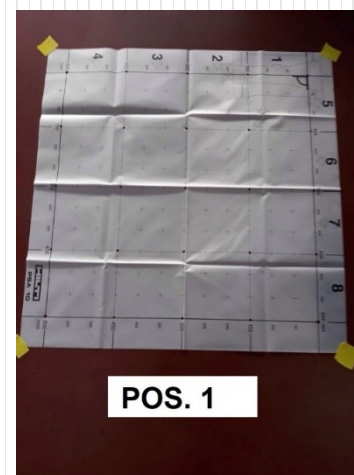

TRASPORTI – LOGISTICA – MEZZI PER MONTAGGIO



STRALIS 480 CON RIBASSATO



GRU ELETTRICA P=10 T RADIOCOMANDATA

SINTESI ATTIVITÀ AZIENDALE

SISTEMA CINQUE SRL **ING. COSTARINI IVANO 348 2689187**

APERTURA A SOLIERA MO NUOVO CENTRO SOLLEVAMENTO
SOLIERA (NO) VIA VIVALDI N. 161 - TEL. 068 860161 - E-MAIL: INFO@SISTEMACINQUE.IT - WWW.SISTEMACINQUE.IT

CARROPONTI - PARANCHI - BANDIERE

INGEGNERIA



- PROGETTI STRUTTURALI
- DISEGNI ESECUTIVI
- RELAZIONI DI CALCOLO
- PLINTI - STRUTTURE METALLICHE

- CERTIFICAZIONI CE IMPIANTI
- CERTIFICAZIONI CE ATTREZZI
- VITA RESIDUA PARANCHI
- VITA RESIDUA PIATTAFORME - GRU

IMPIANTI CHIAVI IN MANO

BANDIERE



GRU A PONTE



IMPIANTI SOSPESI



MANUTENZIONI IMPIANTI - SOTTOGANCI

SERVICE - RICAMBI ORIGINALI

- SERVICE PROGRAMMATO
- RIPARAZIONI
- FIRMA LIBRETTI DI VERIFICA
- VERIFICHE DOCUMENTALI



- SERVIZIO RICAMBI IN 24 ORE
- MODIFICA IMPIANTI
- REVAMPING IMPIANTI
- MESSA A NORMA GRU

COLLAUDI IMPIANTI

- PESI CAMPIONE FINO A 18000 KG
- DINAMOMETRIA
- ESTENSIMETRIA
- LIQUIDI PENETRANTI
- DIAGNOSTICA ARMATURE PAVIMENTI



CORSI DI FORMAZIONE

- UTILIZZO IMPIANTI DI SOLLEVAMENTO
- UTILIZZO ATTREZZI SPECIALI
- UTILIZZO SOTTOGANCI
- UTILIZZO BRACHE - CATENE
- UTILIZZO MAGNETI
- CORSI IN VIDEO CONFERENZA

SISTEMA CINQUE SRL ING. COSTARINI IVANO 348 2689187
SOLIERA (NO) VIA VIVALDI N. 161 - TEL. 068 860161 - E-MAIL: INFO@SISTEMACINQUE.IT - WWW.SISTEMACINQUE.IT